



# Barredora angulable

SA



## Especificaciones técnicas







**Barredora** adaptada para barrer materiales sobre el lado derecho e izquierdo, con cepillos de polipropileno.

**Angulación  $\pm 30^\circ$**  por accionamiento mecánico o hidráulico (opcional).

**Transmisión** con motor hidráulico directo sobre el eje.

# Barredora angulable

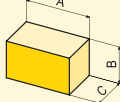
MODELO		SA 155	SA 180	SA 210	SA 220	SA 240	SA 260	
<b>Especificaciones Técnicas</b>	um							
Ancho de trabajo	mm	1550	1800	2100	2200	2400	2600	
Ancho total	mm	1670	1920	2220	2330	2560	2760	
Caudal aceite mín-máx	lt/min	30-40	30-50	50-90	70-100	90-130	100-140	
Presión aceite mín-máxx	bar	160-240		180-240	190-250			
Peso equipamiento estándar	kg	280	310	360	620	660	690	
Material anillo		sostituible en polipropileno						
Anillo	Ø mm	550 x n. 34	550 x n. 39	550 x n. 46	800 x n. 49	800 x n. 53	800 x n. 58	
Angulación mecánica <sup>(1)</sup>		± 30°						
A	mm	365	475	605	917	1011	1091	
B	mm	975	1085	1215	1353	1447	1527	
C	mm	1340	1560	1820	2270	2458	2618	
	ton	2,0-2,8	2,3-3,5	3,5-4,8	–	–	–	
	ton	2,0-3,0	2,8-4,4	4,0-5,6	5,8-8,0	7,5-12,0		
	ton	2,0-3,5	2,9-4,5	4,2-6,2	7,0-9,0	8,0-10,0		
	ton	–	4,0-5,0	4,5-6,0	5,5-8,0	7,5-12,0		
	Dimensiones del equipo sin accesorios	A cm B cm C cm	167 64 120	192 64 120	225 80 120	233 87 183	256 87 183	276 87 183

<sup>(1)</sup> Opcional mecánico

## DIMENSIÓN DE TRABAJO

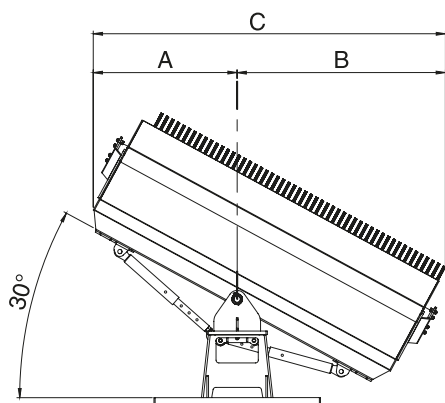

## SISTEMA FLOTANTE

**de serie**  
para el mod. SA 155/180/210

**opcional**  
para el mod. SA 220/240/260

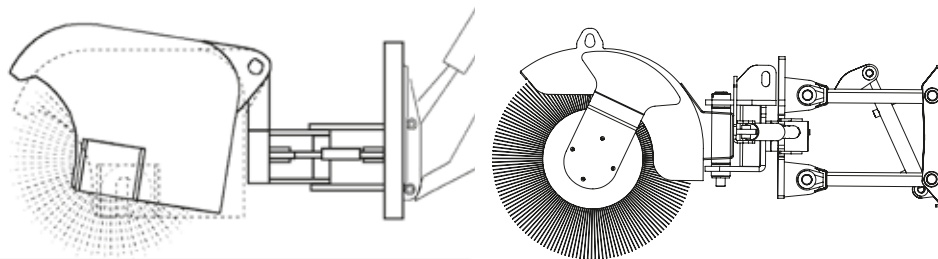

IMPLEMENTOS PARA MAQUINARIA



Via E. Mattei, 4 - 48012 Bagnacavallo RA - Italy  
tel +39 0545 62712 fax +39 0545 62140  
info@gfgordini.com - www.gfgordini.com

LA MEJOR ELECCIÓN DESDE 1985.

